

---

# New Error Code System

## Typical Troubleshooting Cases

---

Technical Support Department

December 19

## **Contents**

Create a  
beautiful life for  
human beings

Introduction of New Codes

Typical Troubleshooting Cases

# Introduction of New Error Codes

# Introduction of New Error Codes



## Current Error Codes

P  
4

Operation lamp	Timer lamp	Code	Meaning of Troubles
☆ 1 time	X	<b>E0</b>	Indoor unit EEPROM parameter error
☆ 2 times	X	<b>E1</b>	Indoor / outdoor units communication error
☆ 3 times	X	<b>E2</b>	Zero-crossing signal detection error (Not available for DC indoor fan motor)
☆ 4 times	X	<b>E3</b>	Indoor fan speed has been out of control
☆ 5 times	X	<b>E4</b>	Indoor room temperature sensor T1 open circuit or short circuit
☆ 6 times	X	<b>E5</b>	Evaporator coil temperature sensor T2 open circuit or short circuit
☆ 7 times	X	<b>EC</b>	Refrigerant leakage detection
☆ 9 times	X	<b>E6/Eb</b>	Communication error between indoor PCB and display PCB
☆ 1 times	O	<b>F0</b>	Over-current protection
☆ 2 times	O	<b>F1</b>	Outdoor ambient temperature sensor T4 open circuit or short circuit
☆ 3 times	O	<b>F2</b>	Condenser coil temperature sensor T3 open circuit or short circuit
☆ 4 times	O	<b>F3</b>	Compressor discharge temperature sensor T5 open circuit or short circuit
☆ 5 times	O	<b>F4</b>	Outdoor unit EEPROM parameter error
☆ 6 times	O	<b>F5</b>	Outdoor fan speed has been out of control (DC fan motor only)
☆ 1 times	☆	<b>P0</b>	IPM malfunction or IGBT over-strong current protection
☆ 2 times	☆	<b>P1</b>	DC voltage between P&N out of range
☆ 3 times	☆	<b>P2</b>	Hi temperature protection of compressor top or IPM
☆ 5 times	☆	<b>P4</b>	Inverter compressor drive error
		<b>P7</b>	AP mode is active but there is no WIFI kit installed
X: OFF                      O: On                      ☆: Flashes in 2Hz			

# Introduction of New Error Codes



Consist of New Error Codes

P



P 0

4

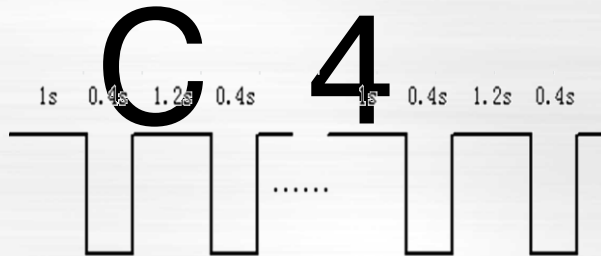

# Introduction of New Error Codes



Consist of New Error Codes

P 0

C 4

H: Indoor Code  
C: Outdoor Code  
L: Other

E: Error  
P: Protection  
F: Faulty  
L: Frequency  
Limitation

Flashes (2Hz) different times to show different codes  
On, off or flashes (2Hz) to show different codes

fresh defrost run timer  
○ ○ ○ ○



# Introduction of New Error Codes



## New Error Codes

Operation lamp	Timer lamp	Code	Meaning of Troubles
☆ 1 time	X	<b><i>EH 00</i></b>	Indoor unit EEPROM parameter error
☆ 2 times	X	<b><i>EL 01</i></b>	Indoor / outdoor units communication error
☆ 3 times	X	<b><i>EH 02</i></b>	Zero-crossing signal detection error (Not available for DC indoor fan motor)
☆ 4 times	X	<b><i>EH 03</i></b>	Indoor fan speed has been out of control
☆ 6 times	X	<b><i>EH 60</i></b>	Indoor room temperature sensor T1 open circuit or short circuit
☆ 6 times	X	<b><i>EH 61</i></b>	Evaporator coil temperature sensor T2 open circuit or short circuit
☆ 8 times	X	<b><i>EL 0C</i></b>	Refrigerant leakage detection
☆ 9 times	X	<b><i>EH 0b</i></b>	Communication error between indoor PCB and display PCB
☆ 1 times	☆	<b><i>PC 08</i></b>	Over-current protection
☆ 5 times	X	<b><i>EC 53</i></b>	Outdoor ambient temperature sensor T4 open circuit or short circuit
☆ 5 times	X	<b><i>EC 52</i></b>	Condenser coil temperature sensor T3 open circuit or short circuit
☆ 5 times	X	<b><i>EC 54</i></b>	Compressor discharge temperature sensor T5 open circuit or short circuit
☆ 5 times	X	<b><i>EC 51</i></b>	Outdoor unit EEPROM parameter error
☆ 12 times	X	<b><i>EC 07</i></b>	Outdoor fan speed has been out of control (DC fan motor only)
☆ 7 times	☆	<b><i>PC 00</i></b>	IPM malfunction or IGBT over-strong current protection
☆ 2 times	☆	<b><i>PC 01</i></b>	DC voltage between P&N out of range
☆ 3 times	☆	<b><i>PC 02</i></b>	Hi temperature protection of compressor top or IPM
☆ 5 times	☆	<b><i>PC 04</i></b>	Inverter compressor drive error
		<b><i>FH 0P</i></b>	AP mode is active but there is no WIFI kit installed
X: OFF			O: On
			☆: Flashes in 2Hz

# Typical Troubleshooting Cases



- *Communication Error between indoor and outdoor unit*
- *E1 (EL01)*

<b>Error Code</b>	<b>E1 (EL01)</b>
<b>Malfunction decision conditions</b>	Indoor unit does not receive the feedback from outdoor unit during <b>110</b> seconds and this condition happens <b>four times</b> continuously.
<b>Possible causes</b>	<ul style="list-style-type: none"><li>• Wiring mistake</li><li>• Faulty indoor or outdoor PCB</li><li>• Faulty EEV</li><li>• Faulty reactor</li></ul>

# Typical Troubleshooting Cases



- Communication Error between indoor and outdoor unit
- E1 (EL 01)

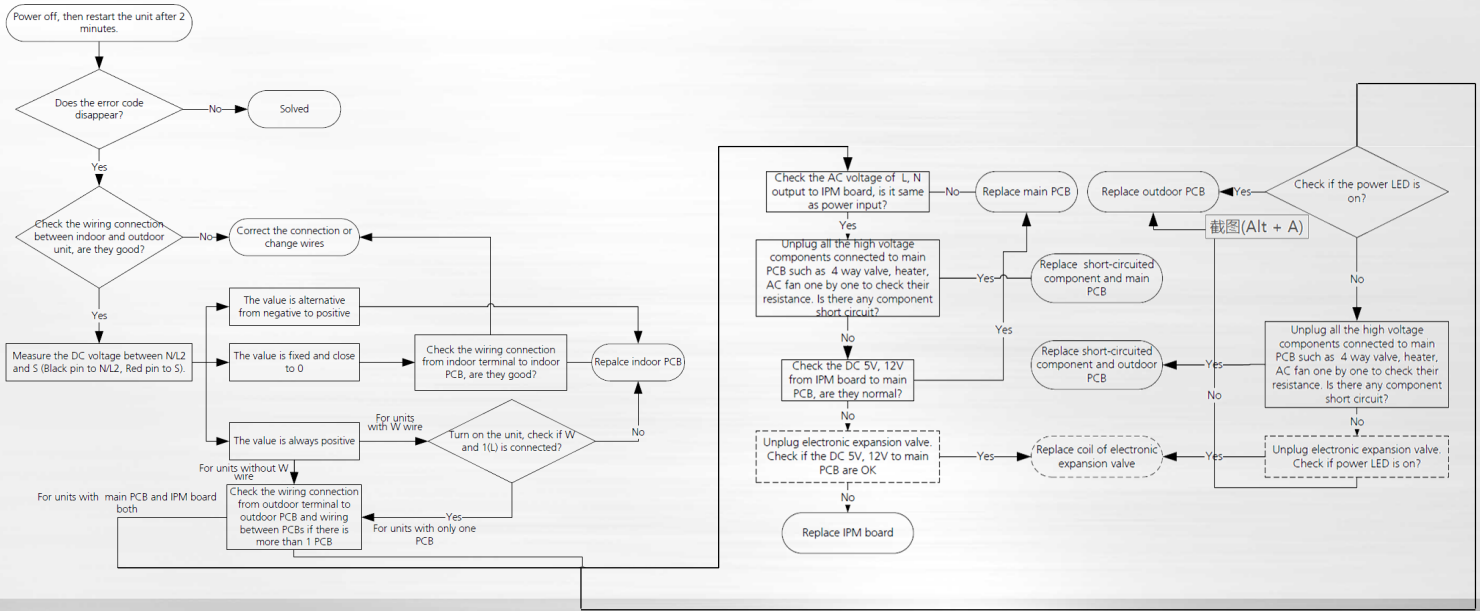

# Typical Troubleshooting Cases

- *Communication Error between indoor and outdoor unit*
- *E1 (EL 01)*

First, check that the connections are integrated and correct.

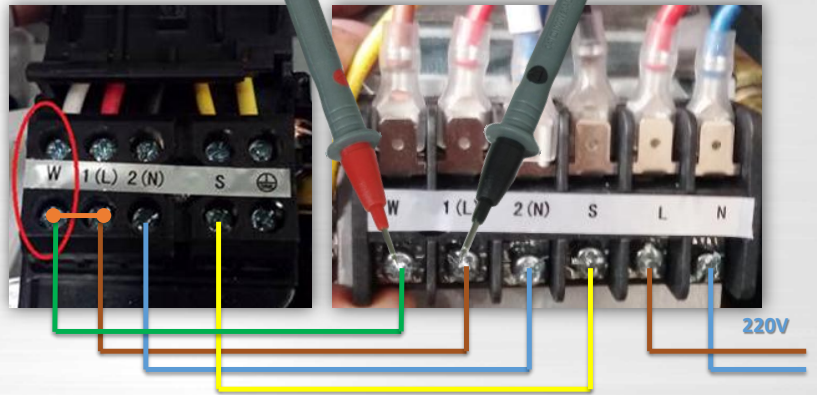
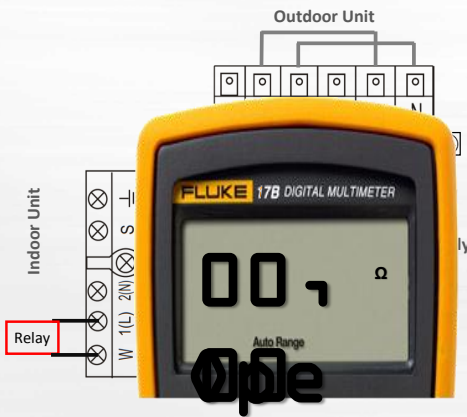

Note: sometimes, it is necessary to test with a temporary cable, because if the cable is bitten, it is likely that the multi-meter indicates continuity by some filament that has been left, but it is not enough for the cable to communicate correctly.

# Typical Troubleshooting Cases

- *Communication Error between indoor and outdoor unit*
- *E1 (EL 01)*

## Frame of Indoor PCB

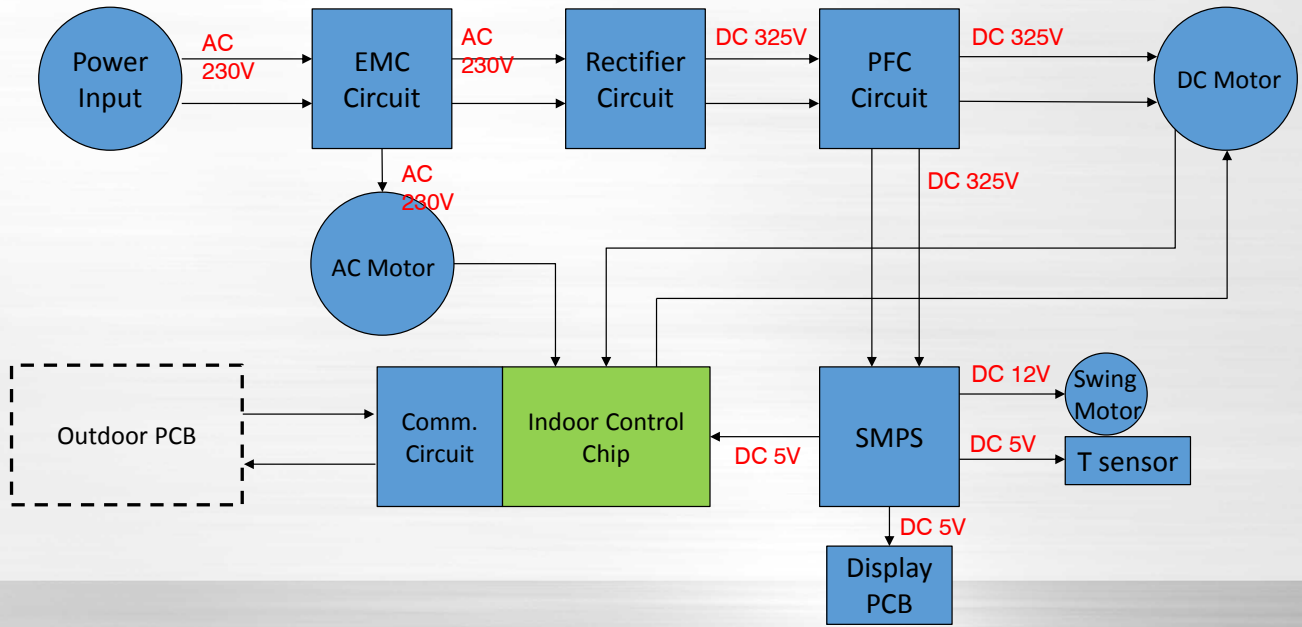

# Typical Troubleshooting Cases

- Communication Error between indoor and outdoor unit
- E1 (EL 01)

Port	Description	Parameter	Remark
CN3	Power output for DC Fan		
CN8	Power output for swing motor of louver	12V/DC	
CN20	Power output for swing motor of vertical louver	12V/DC	Reserved
CN7	Power output for room temperature sensor T1	5V/DC	
CN6	Power output for evaporator temperature sensor T2	5V/DC	
CN10A	Power output and communication for display board	5V/DC	
CN225	Power output for ionizer or plasma	230V/AC	Reserved
CN51	Port for 12V output	12V/DC	

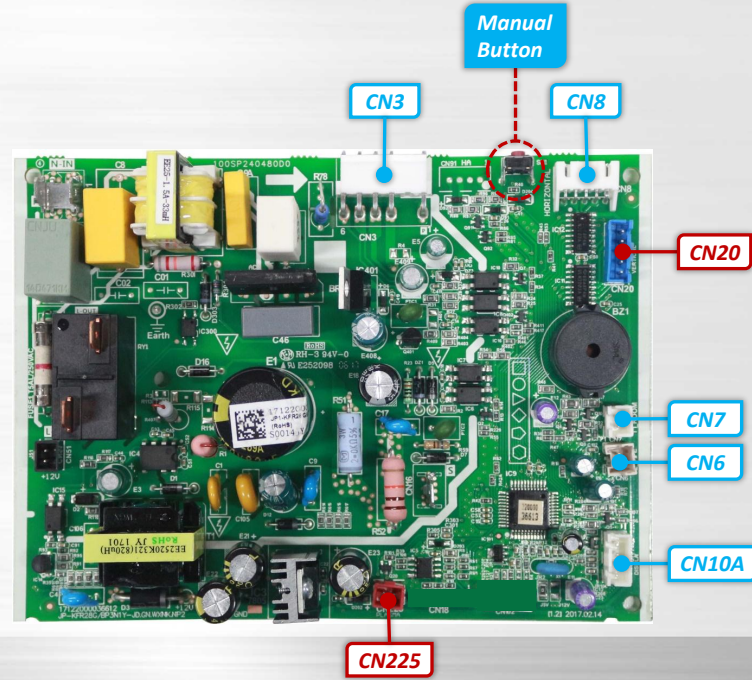

# Typical Troubleshooting Cases

- *Communication Error between indoor and outdoor unit*
- *E1 (EL 01)*

Then, perform voltage measurements between 2 and 3.  
(it is recommended to place the multi-meter on a 100V scale)

The values will move alternatively from negative value to positive value.

If the voltage is only positive value, it indicates a problem is in the outdoor PCB and must be replaced.

If the voltage is fixed and very close to zero, it indicates that the problem may be in the cable or on the indoor PCB.

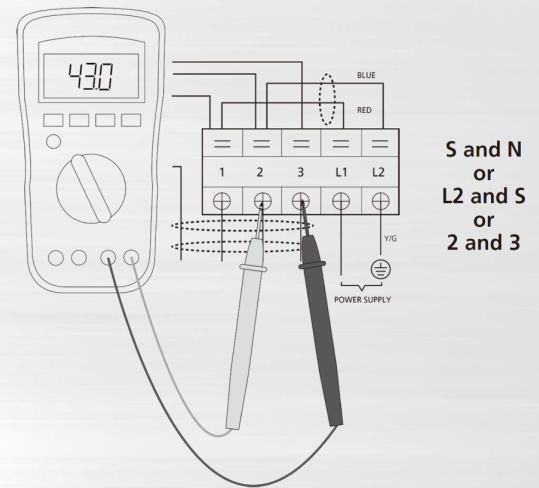

# Typical Troubleshooting Cases

- Communication Error between indoor and outdoor unit
- E1 (EL 01)

## Frame of Outdoor PCB

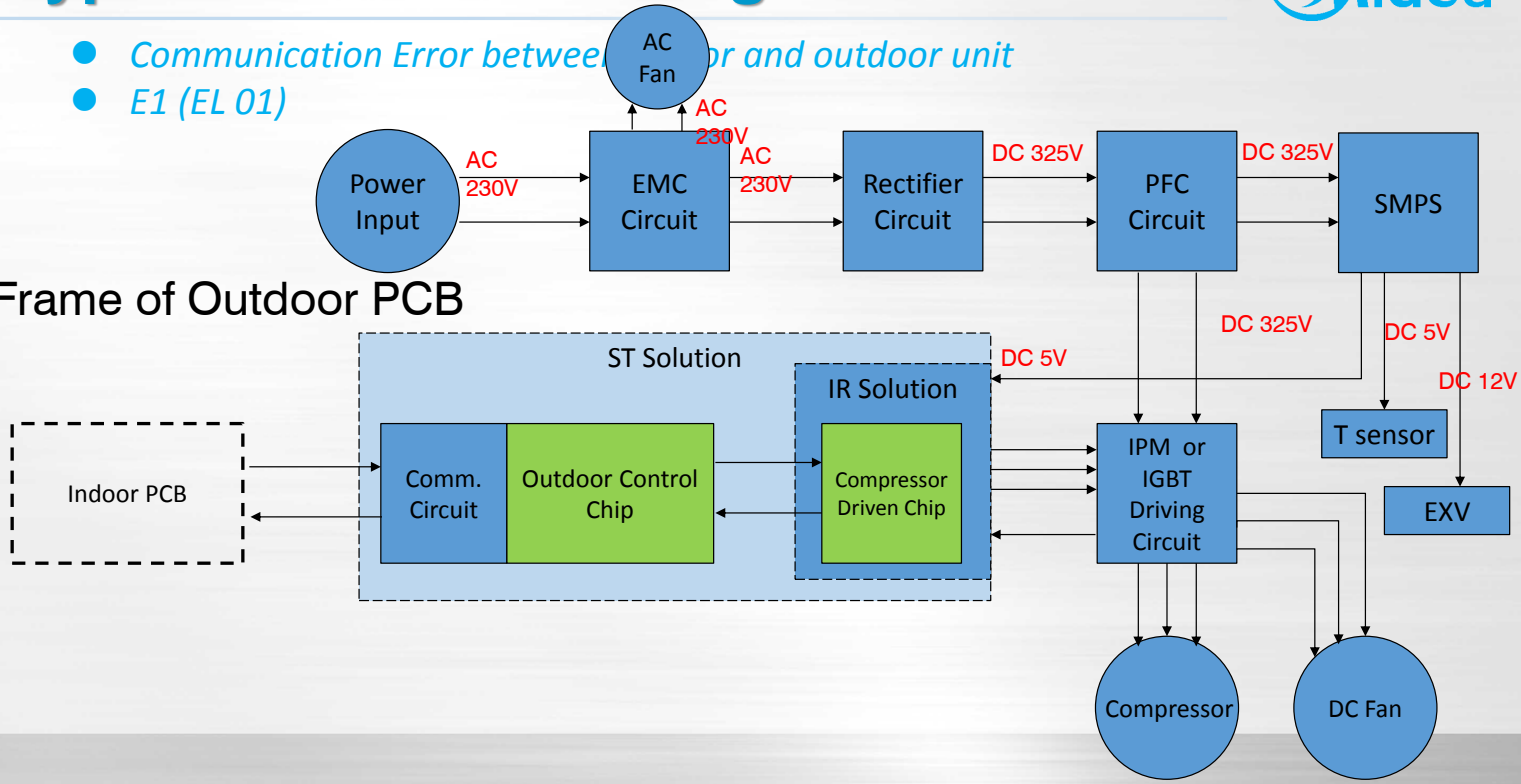

# Typical Troubleshooting Cases

- Communication Error between indoor and outdoor unit
- E1 (EL 01)

Port	Description	Parameter
CN3	Port for earth wire	
CN1	Port for neutral wire	
CN2	Port for live wire	
CN16	Port for communication cable S	
CN17	Power output for compressor heater	230V/AC
CN60	Power output for 4-way valve	230V/AC
CN15	Power output for chassis heater	230V/AC
CN25	Power output for AC fan	230V/AC
CN22	Power output for condenser (T3), ambient (T4) and discharge (Tp) temperature sensors	5V/DC
CN31	Power output for EEV	12V/DC
CN7	Port for DC fan	0-200V/AC
CN6	Port for test board	5V/DC
CN50	Port for Compressor	0-200V/AC

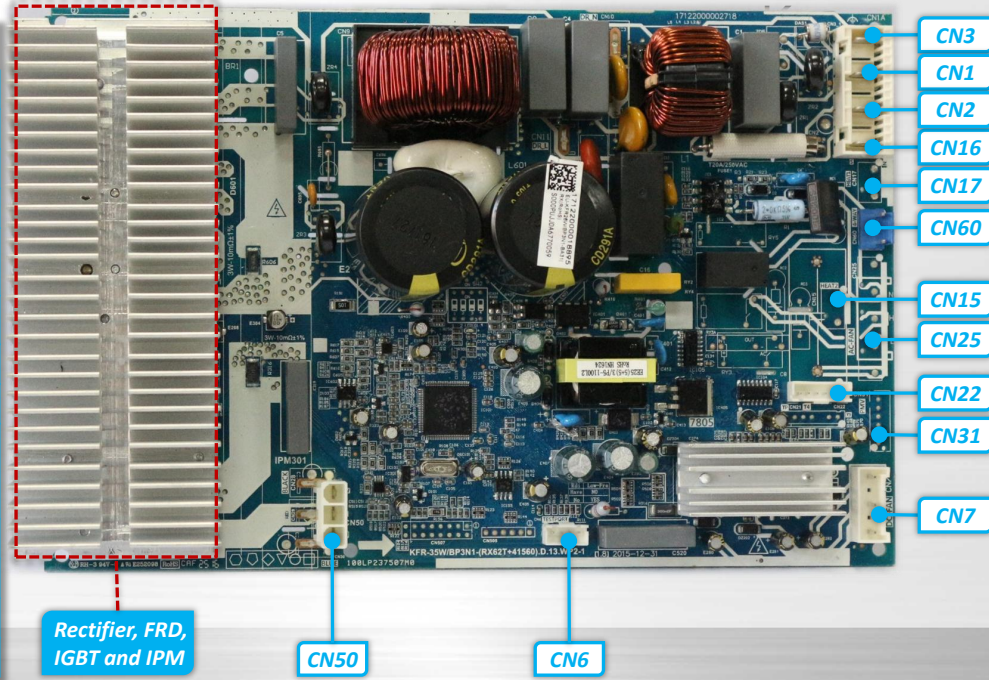

# Typical Troubleshooting Cases

- Communication Error between indoor and outdoor unit
- E1 (EL 01)

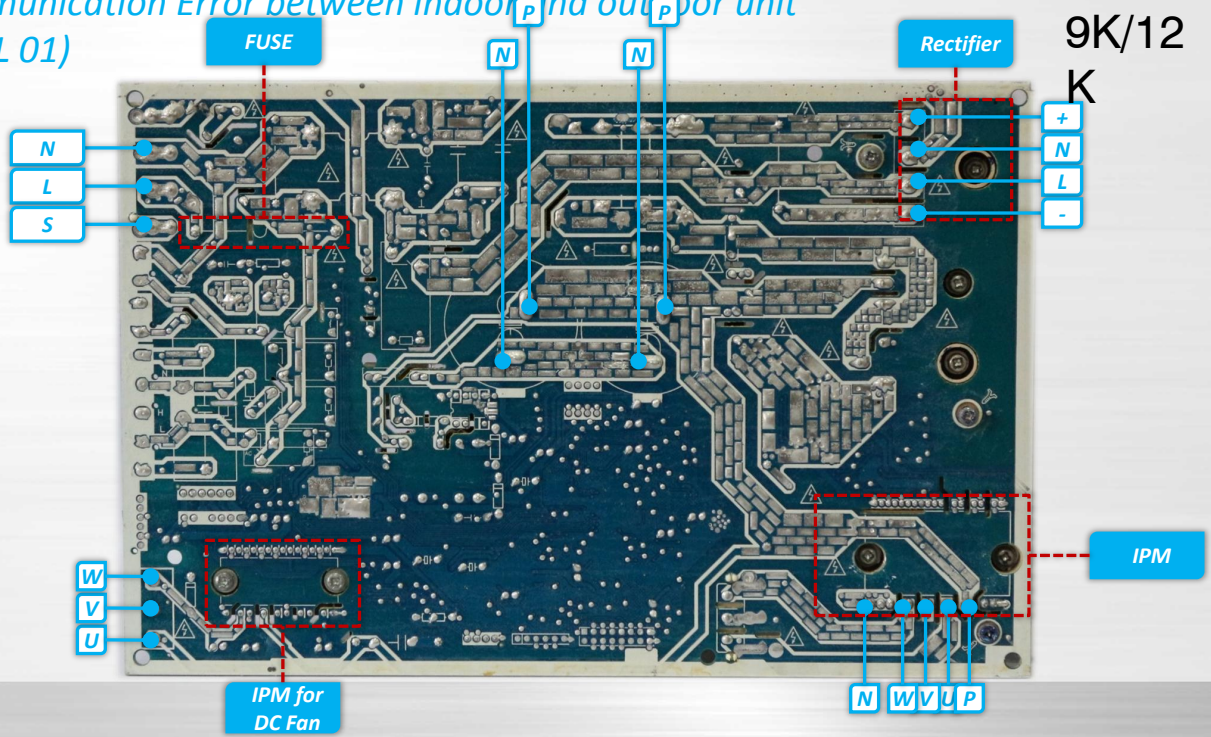

# Typical Troubleshooting Cases

- *Communication Error between indoor and outdoor unit*
- *E1 (EL 01)*

## 1. Check AC input

Check AC voltage value between **L** and **N**. If the measured value is around 230V, then go to next step.

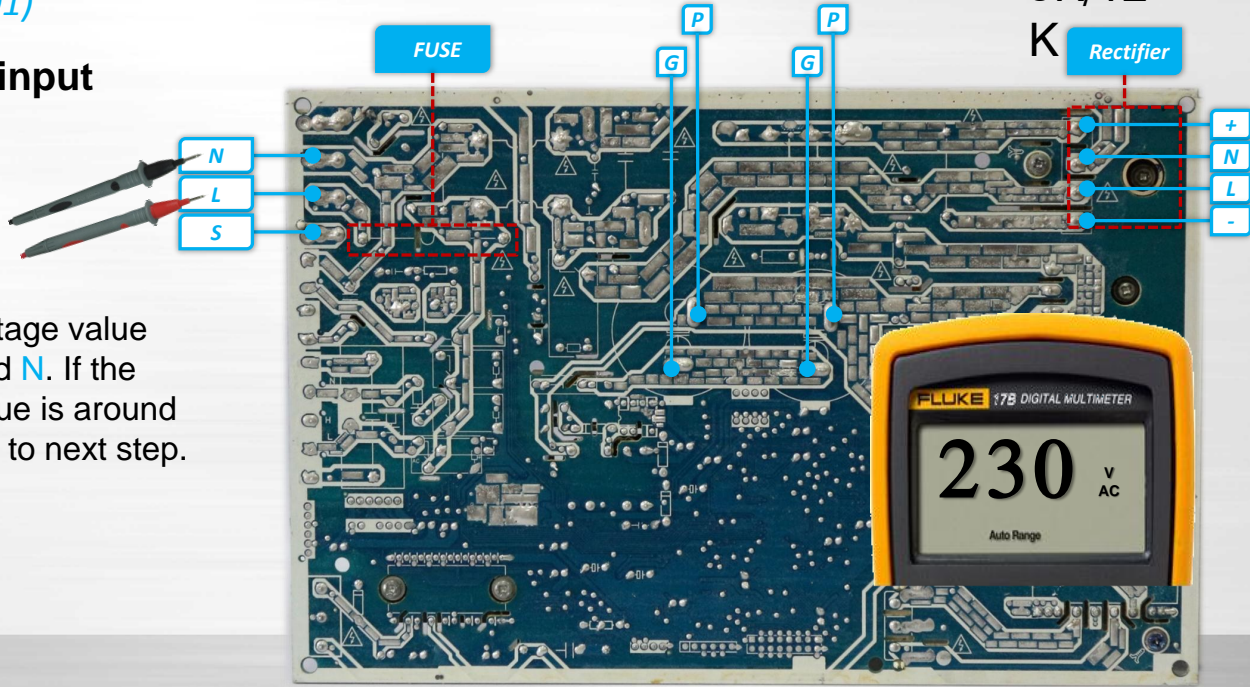

# Typical Troubleshooting Cases

- *Communication Error between indoor and outdoor unit*
- *E1 (EL 01)*

## 2. Check Rectifier's AC input

Check Rectifier's AC input voltage value between **L** and **N**. If the measured value is around 230V, it means the fuse, the inductor and the NTC are ok, then go to next step.

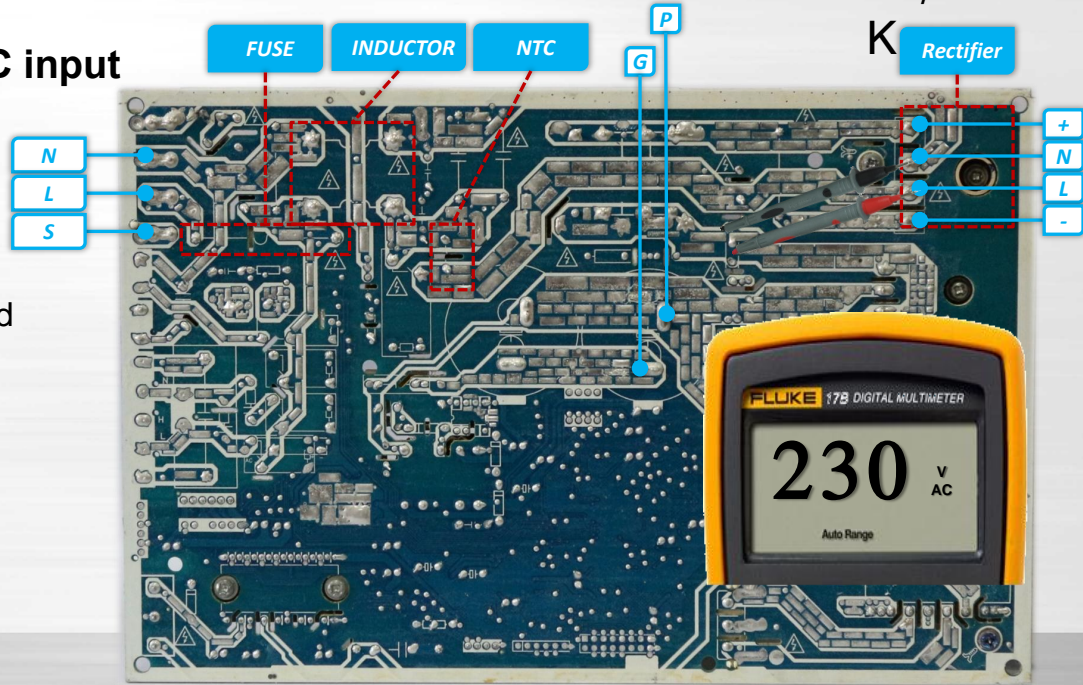

# Typical Troubleshooting Cases

- *Communication Error between indoor and outdoor unit*
- *E1 (EL 01)*

## 3. Check Rectifier's DC output

Check Rectifier's DC output voltage value between + and -. If the measured value is around 325V, it means the rectifier is ok, then go to next step.

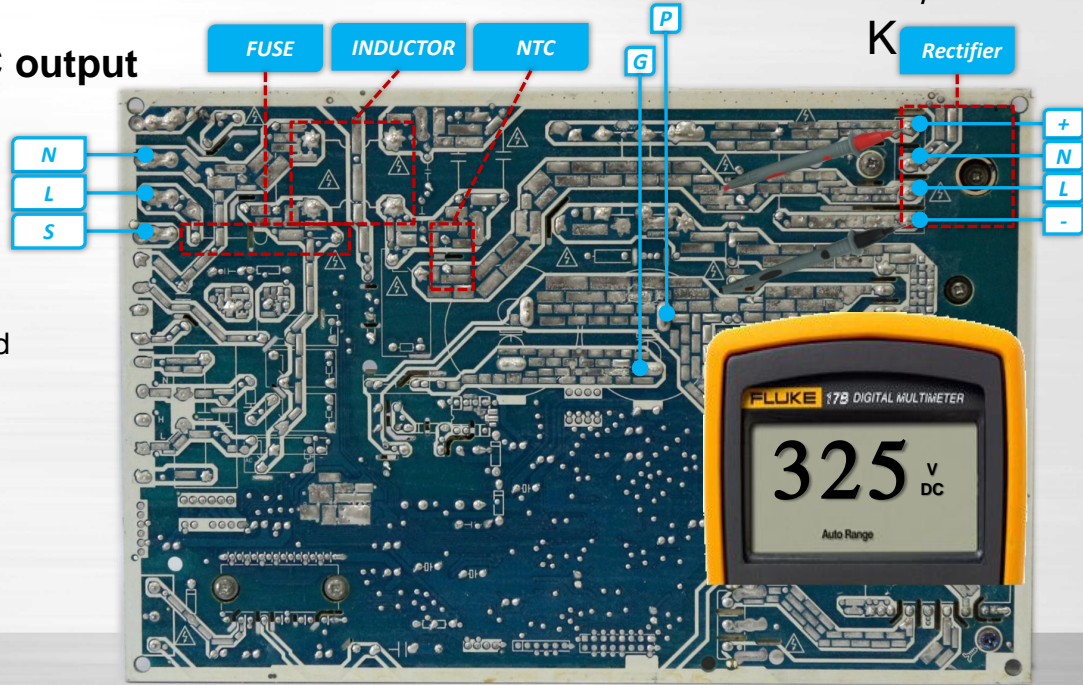

# Typical Troubleshooting Cases

- Communication Error between indoor and outdoor unit
- E1 (EL 01)

## 4. Check PG Voltage

Check PG's DC voltage and it should higher than 300V, it means the capacitor, the PFC inductor and the FRD are ok, then go to next step.

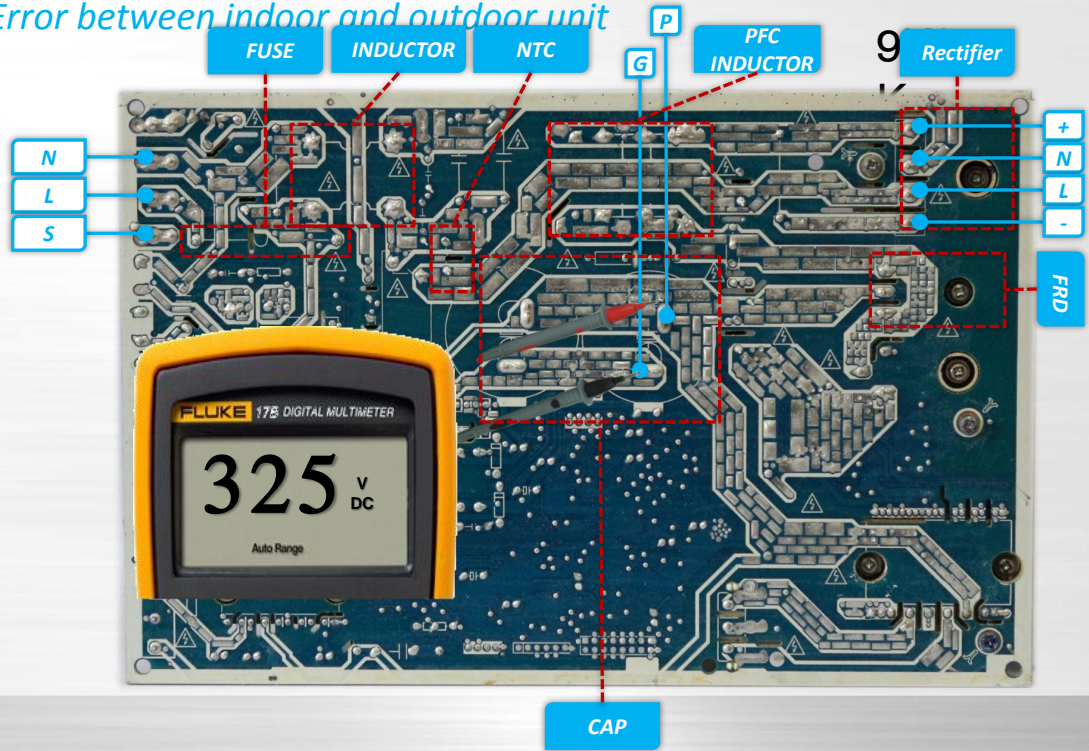

# Typical Troubleshooting Cases

- Communication Error between indoor and outdoor unit
- E1 (EL 01)

## 5. Check SMPS Voltage

Check SMPS DC voltage and it supply 15VDC, 12VDC and 5VDC. If 3 voltage is correct, it means the SMPS is ok, then may be the MCU failure.

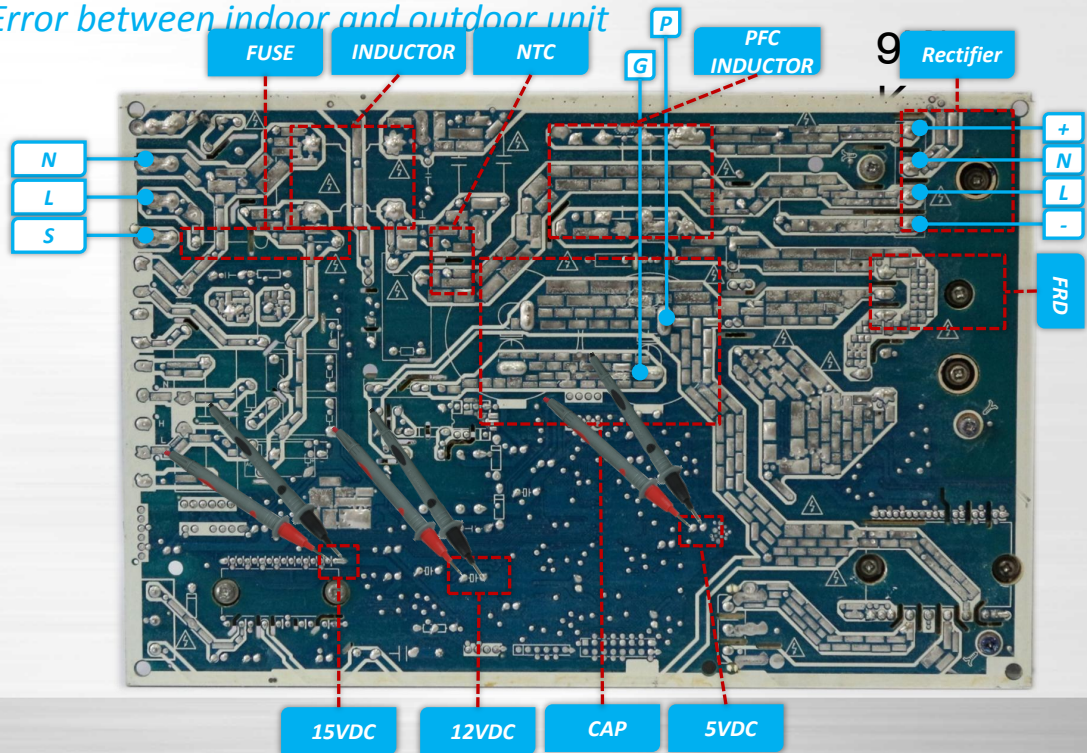

# Typical Troubleshooting Cases

- Communication Error between indoor and outdoor
- E1 (EL 01)

18K/24  
K

Port	Description	Parameter
CN25	Port external reactor	310V/DC (to GND)
CN21	Port for DR module	
CN3	Port for power cable (E,N,L,S)	
CN60	Power output for 4-way valve	230V/AC
CN4	Power output for compressor heater	230V/AC
CN5	Power output for AC fan	230V/AC
CN16	Power output for chassis heater	230V/AC
CN18	Power output for EEV	12V/DC
CN23	Port for test board	5V/DC
CN414	Port for DC fan	0-200V/AC
CN17	Power output for condenser (T3), ambient (T4) and discharge (Tp) temperature sensors	5V/DC
CN19	Port for DC fan	310V/AC
CN30	Port for Compressor	0-200V/AC

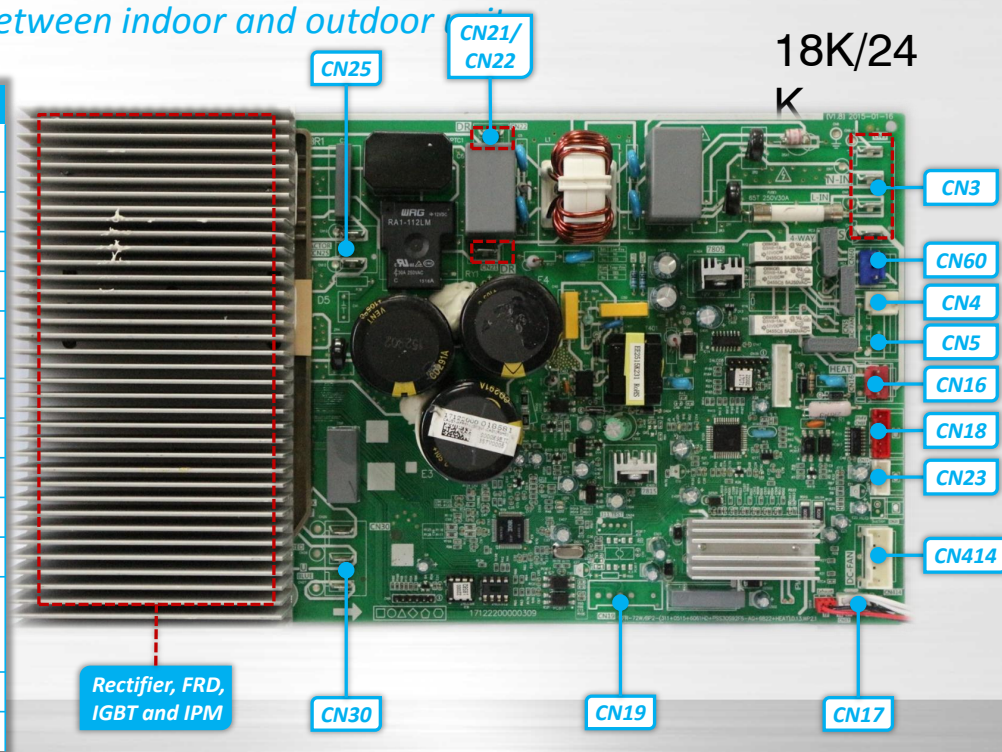

# Typical Troubleshooting Cases

- Communication Error between indoor and outdoor unit
- E1 (EL 01)

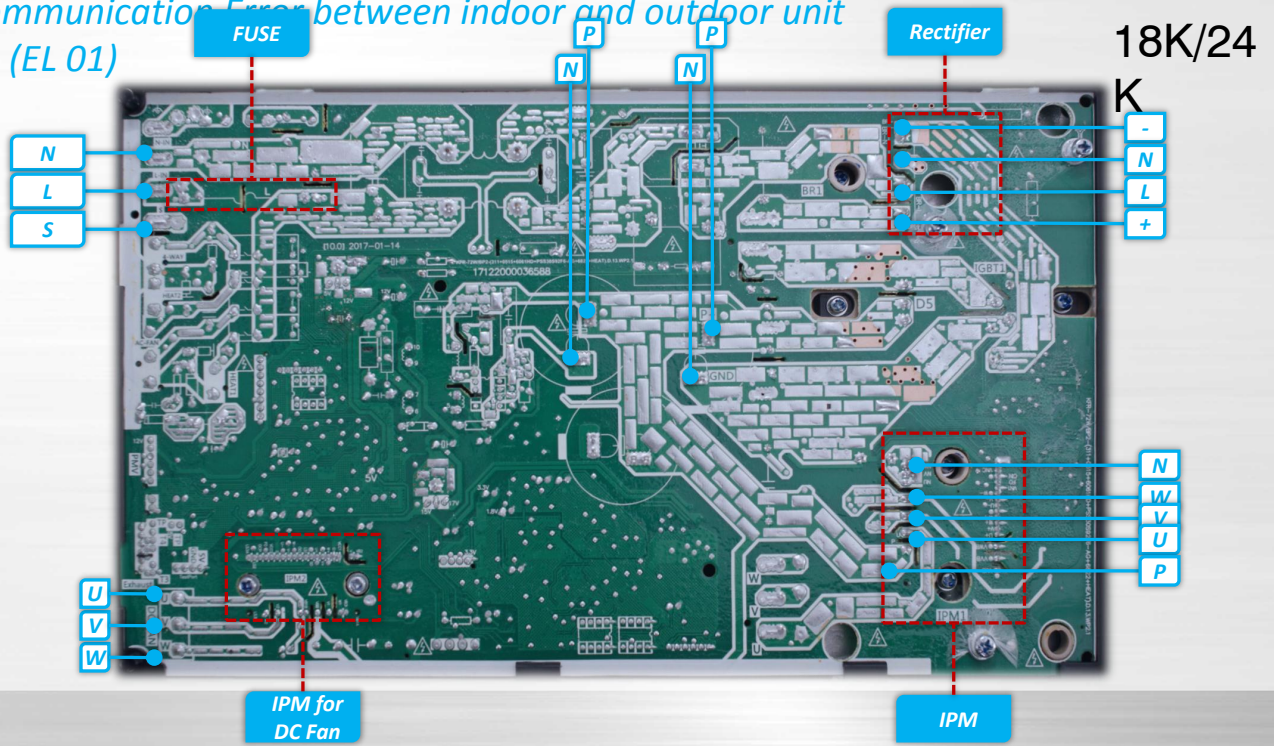

# Typical Troubleshooting Cases

- *Communication Error between indoor and outdoor unit*
- *E1 (EL 01)*

18K/24  
K

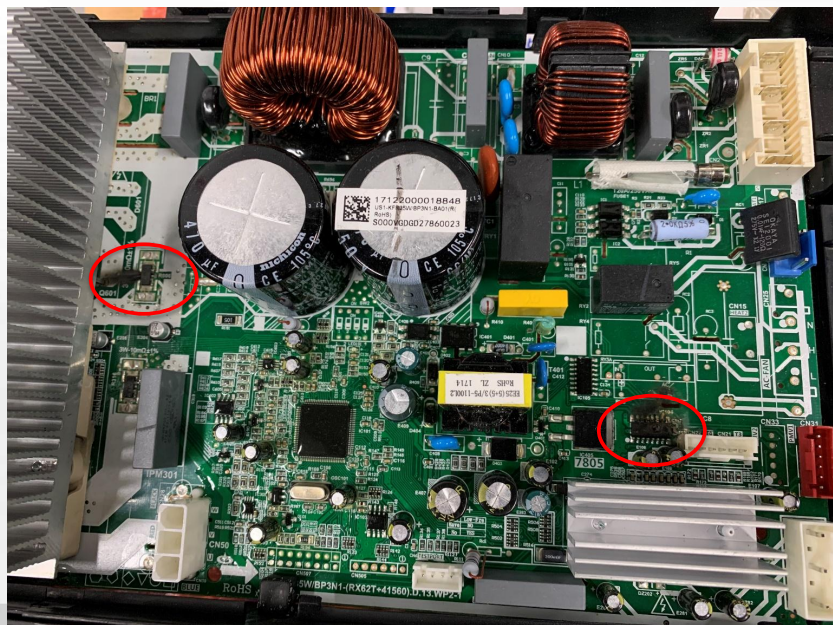

# Typical Troubleshooting Cases

- Communication Error between indoor and outdoor unit
- E1 (EL 01)

24K/30K

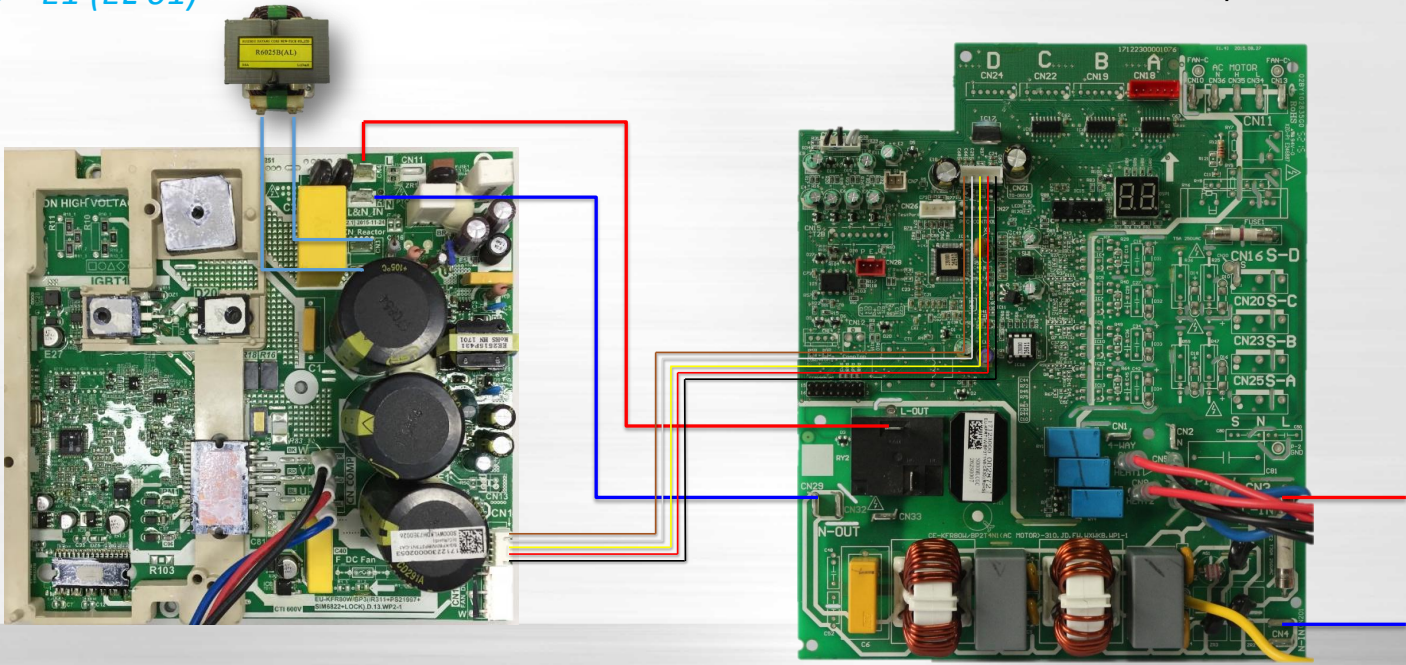

# Typical Troubleshooting Cases



- Communication Error between indoor and outdoor
- E1 (EL 01)

Port	Description	Parameter
CN14	Output for DC fan	
CN1	Communication port with main board	5V, 12V/DC
CN2 CN3	Connection ports for reactor	320V/DC
CN5	N port for AC input	5V/DC
CN4	L port for AC input	230V/AC

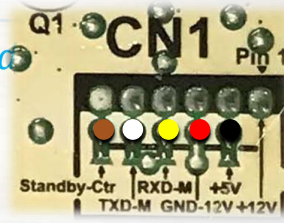

24K/30K

## IPM Board

Driving Chip

IPM for DC Fan

IPM for Compressor

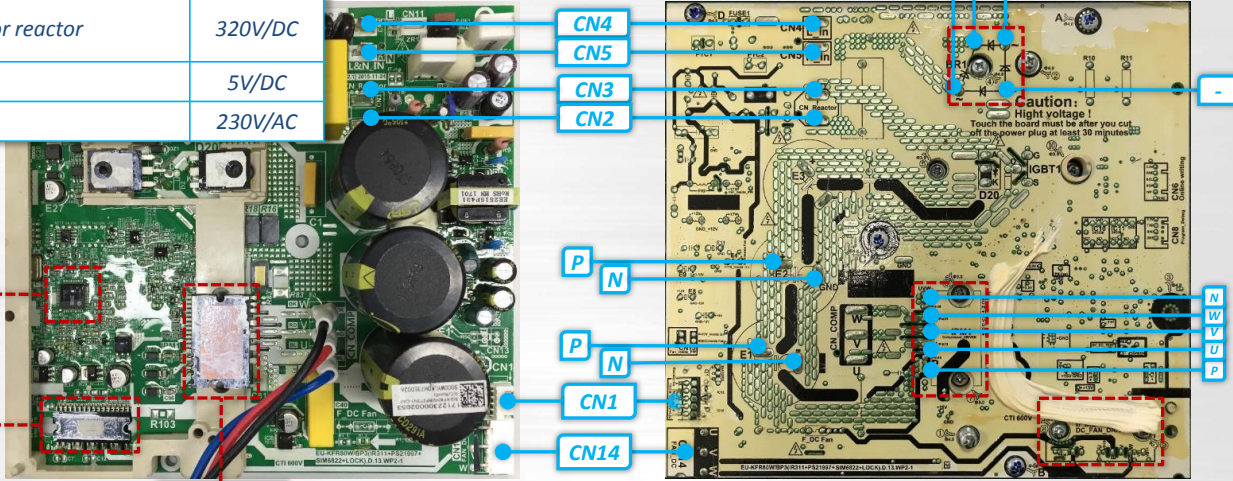

# Typical Troubleshooting Cases

- *Communication Error between indoor and outdoor unit*
- *E1 (EL 01)*

36K/42K  
(1Ph)

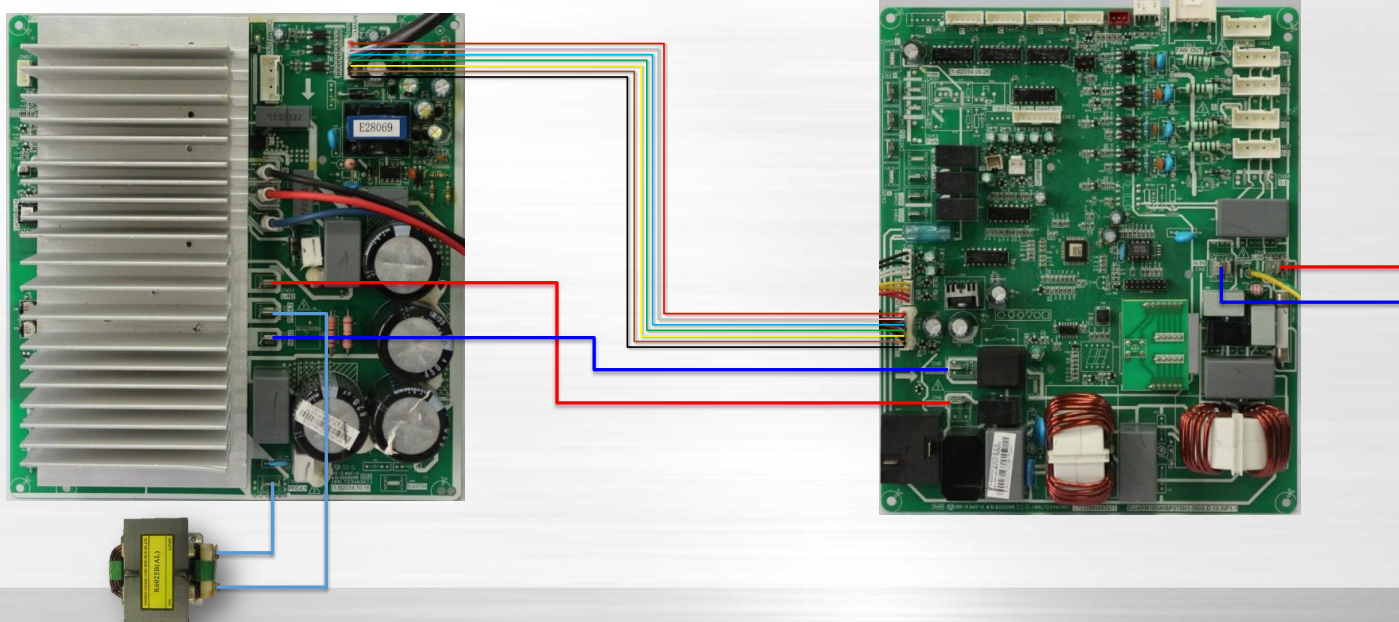

# Typical Troubleshooting Cases

- Communication Error between indoor and outdoor unit
- F1 (E1 01)

36K/42K  
(1Ph)

Port	Description	Parameter
CN19	Output for DC fan	
CN55	Communication port with main board	5V, 12V/DC
CN51 CN52	Connection ports for reactor	320V/DC
CN53	N port for AC input	5V/DC
CN54	L port for AC input	230V/AC
UVW	Output for compressor	

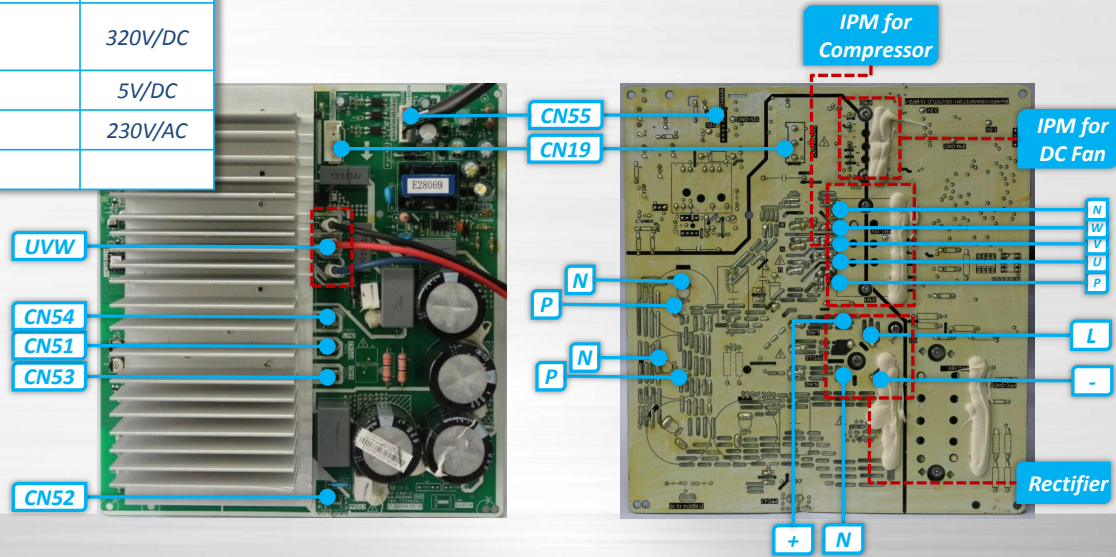

# Typical Troubleshooting Cases

- *Communication Error between indoor and outdoor unit*
- *E1 (EL 01)*

*The cases about the wiring cause the E1*

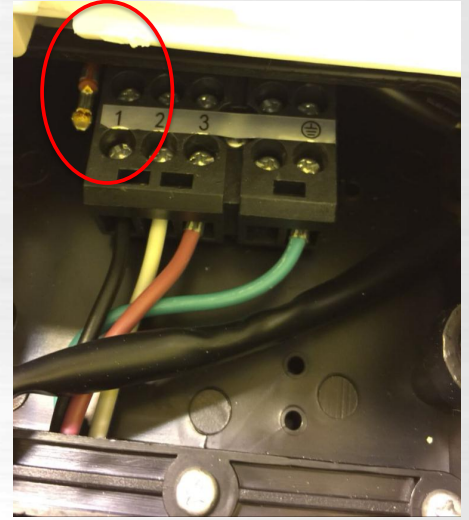
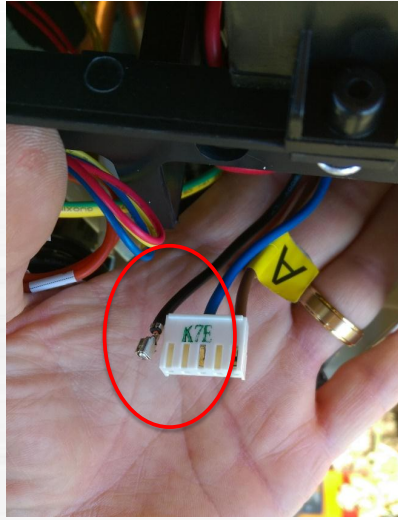
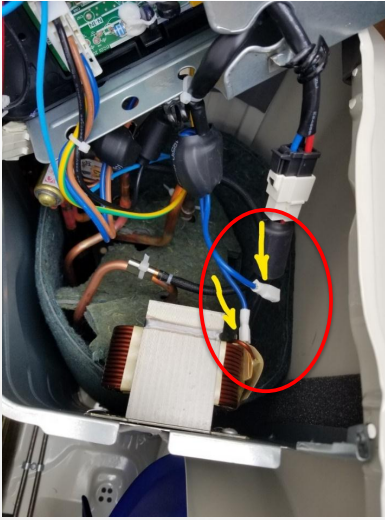

# Typical Troubleshooting Cases

- *Communication Error between indoor and outdoor unit*
- *E1 (EL 01)*

*Other cases cause the E1*

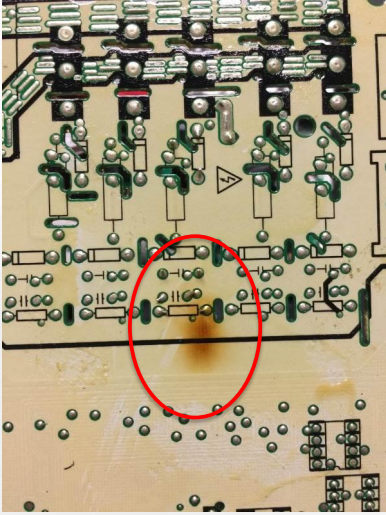

# Typical Troubleshooting Cases



- Inverter compressor drive error
- P4 (PC 04)

<b>Error Code</b>	<b>P4(DP)</b> <b>P40/P41/P42/P43/P44/P45/P46/</b> <b>P49(DB)</b>
<b>Malfunction decision conditions</b>	<b>An abnormal inverter compressor drive is detected by a special detection circuit, including communication signal detection, voltage detection, compressor rotation speed signal detection and so on.</b>
<b>Possible causes</b>	<ul style="list-style-type: none"> <li>● Wiring mistake</li> <li>● IPM malfunction</li> <li>● Faulty outdoor fan motor</li> <li>● Compressor malfunction</li> <li>● Faulty outdoor PCB</li> <li>● Surge</li> <li>● System blockage</li> </ul>

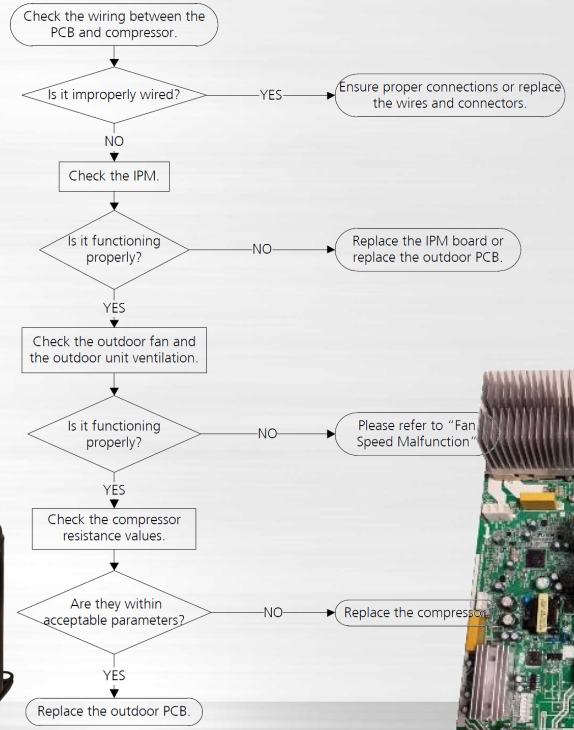

# Typical Troubleshooting Cases

- *Inverter compressor drive error*
- *P4 (PC 04)*

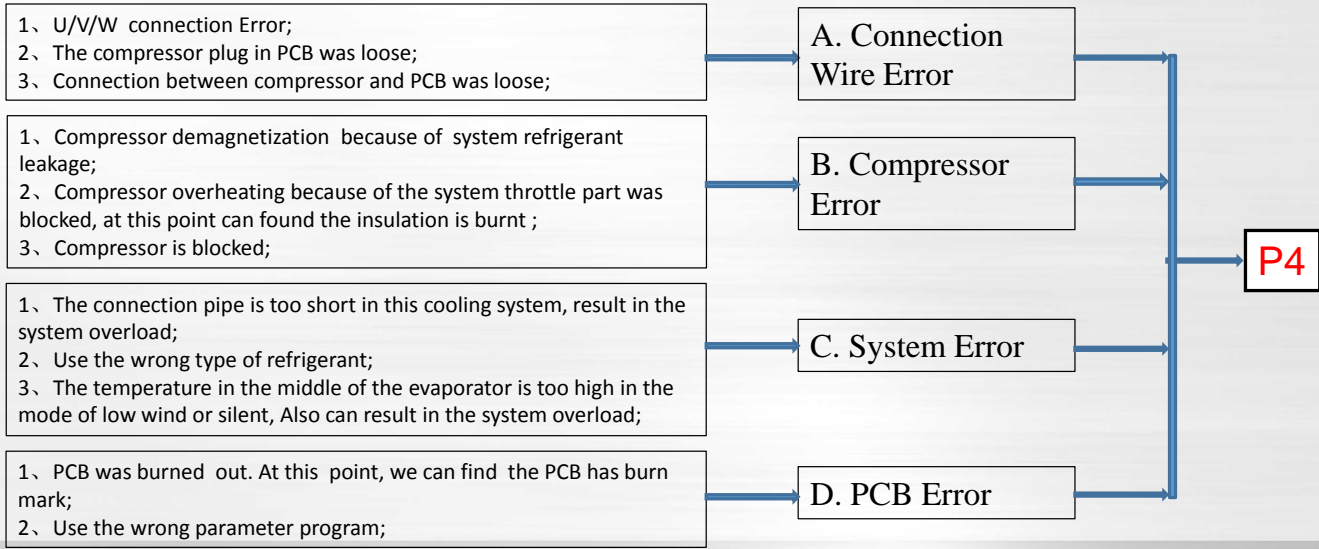

# Typical Troubleshooting Cases



- Inverter compressor drive error
- P4 (DP Error Code)
- P40/P41/P42/P43/P44/P45/P46/P49 (DB Error Code)

Error Code	Explanation	Damaged Part
<b>P40</b>	Communication error between main control chip and drive chip	Outdoor PCB or IPM board
<b>P41</b>	Error of current sampling circuit of compressor	Outdoor PCB or IPM board
<b>P42</b>	Error of compressor start up	Compressor
<b>P43</b>	Lack phase protection	Connection cable of compressor
<b>P44</b>	Zero speed protection	Outdoor PCB or IPM board, or compressor
<b>P45</b>	Synchronization error between 341 chip and PWM	Outdoor PCB or IPM board
<b>P46</b>	Compressor speed out of control	Outdoor PCB or IPM board, or compressor
<b>P49</b>	Error of over current of compressor	Outdoor PCB or IPM board, compressor or refrigeration system

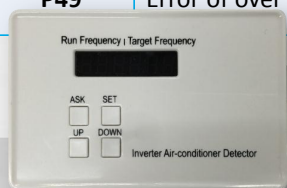

JC-01

BOM Code: 17222000A55250



BOM Code: 17222000A55927



# Typical Troubleshooting Cases



- *Inverter compressor drive error*
- *P4 (PC 04)*

## Causes of Compressor Stop

Code	Reasons of compressor stop	Code	Reasons of compressor stop
1	Frequency limit caused by current	24	IPM overcurrent protection (P0)
2	Frequency limit caused by T2 in cooling	25	Compressor lack of phase (P43)
3	Frequency limit caused by T2 in heating	26	Compressor malfunction
4	Set temperature reached	27	Low voltage protection of compressor driven chip
5	Frequency limit caused by T4	28	DC Fan current protection (F5)
6	Defrosting	29	DC Fan lack of phase (F5)
7	Mode switching	30	DC Fan zero speed protection (F5)
9	High discharge temperature protection	31	PFC module protection
10	High evaporator coil temperature T2 protection	32	High voltage protection of compressor driven chip
11	Evaporator low temperature T2 protection	33	Compressor Zero speed malfunction (P44)
12	Condenser high temperature T3 protection	34	Compressor PWM malfunction (P45)
13	Low indoor room temperature protection in drying mode	35	Compressor MCE malfunction (P12)
14	Low ambient temperature protection	36	Compressor overcurrent protection (P49)
15	Refrigerant leakage detection (EC)	37	Compressor EEPROM malfunction
16	Communication malfunction between indoor and outdoor units (E1)	38	Compressor start-up malfunction (P42)
17	Communication error between outdoor main chip and compressor driven chip (P40)	39	Compressor speed is out of control (P46)
18	AC power input voltage protection	40	Low pressure protection
19	Top temperature protection of compressor (P2)	41	High pressure protection
20	Outdoor EEPROM Malfunction (F4)	42	PFC module malfunction
21	Indoor fan speed malfunction (E3)	49	Shutdown stop
22	Temperature sensor open or short circuit (E4/E5/F1/F2/F3)	50	Electrical disconnect
23	Overcurrent protection (F0)	51	DR stop

# Typical Troubleshooting Cases



- Inverter compressor drive error
- P4 (PC 04)



In “Parameter Checking” mode, the screen will display the code name for 2 seconds, and then the information for 25 seconds. The meaning of codes are as right table shows. **If there is no any operation in this 27s or other button is pressed, the unit will quit this mode.**

## Parameter Checking operation

Displaying code	Meaning
T1	Room temperature
T2	Indoor coil temperature
T3	Outdoor coil temperature
T4	Ambient temperature
Tb	Outlet temperature of indoor coil
TP	Discharge temperature
TH	Suction temperature
FT	Targeted Frequency
Fr	Actual Frequency
IF	Indoor fan speed
OF	Outdoor fan speed
LA	EXV opening steps
CT	Compressor continuous running time
ST	Causes of compressor stop.
A0, A1, 0, 1, 2, 3, 4, 5, 6, L, A, U, T	Reserved

# Typical Troubleshooting Cases

- *Inverter compressor drive error*
- *P4 (PC 04)*

Step 1. Confirm whether the wiring of outdoor unit power, main PCB and IPM board are correct or not, and whether the connecting is loose.

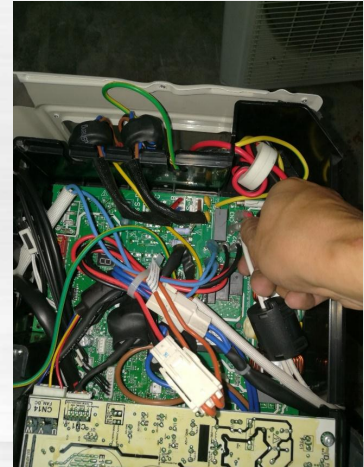

# Typical Troubleshooting Cases

- *Inverter compressor drive error*
- *P4 (PC 04)*

Step 1. Confirm whether the wiring of outdoor unit power, main PCB and IPM board are correct or not, and whether the connecting is loose.

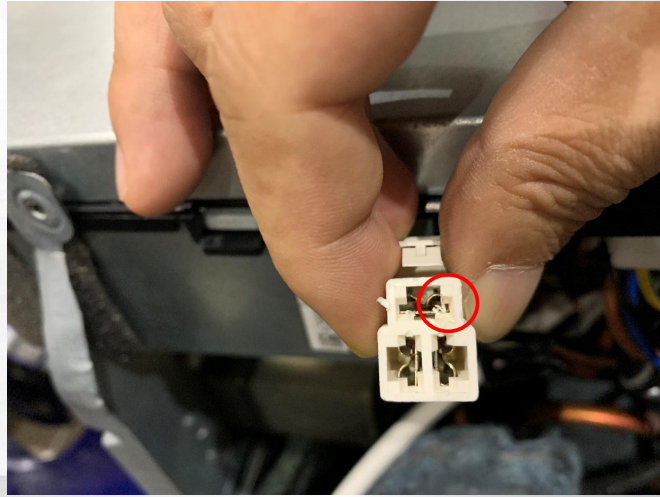

# Typical Troubleshooting Cases

- Inverter compressor drive error
- P4 (PC 04)

Step 2. Please record the status of the red light and green light of the module board when confirming the fault.

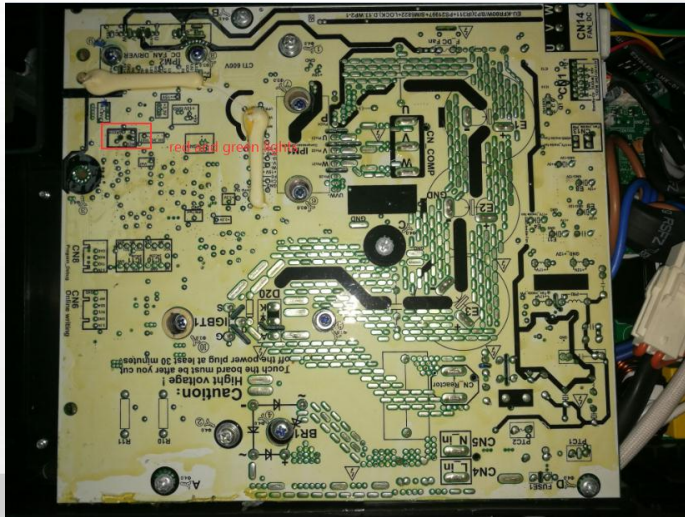

# Typical Troubleshooting Cases

- *Inverter compressor drive error*
- *P4 (PC 04)*

Step 3. Measure the bus voltage at startup and failure. After starting up the compressor, the bus voltage will change to about 310~330V. If the bus voltage is significantly different from this value, to confirm whether the wiring of the module board is firm.

The relation of the input voltage and DC bus voltage when standby (DC bus voltage means the high voltage electrolytic capacitor voltage between two pins):

$$V_{DC} = V_{ACin} * 1.414$$

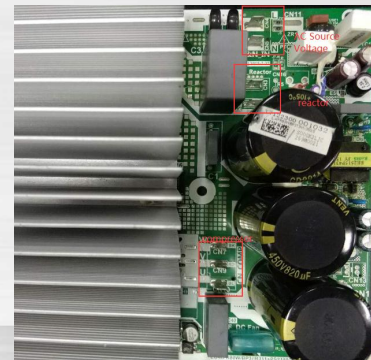
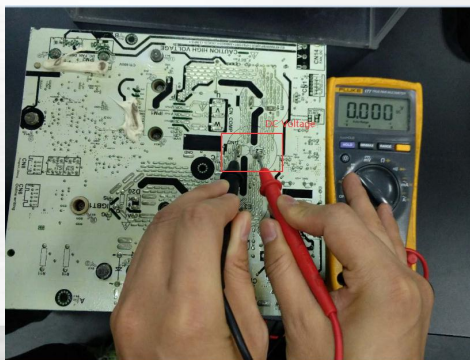

# Typical Troubleshooting Cases

- *Inverter compressor drive error*
- *P4 (PC 04)*

Step 4. check the reactor wiring and resistance (between pins). The normal resistance should be around  $0.1\Omega$ .

Check the resistance between either pin and metal part of outdoor unit. It is supposed to be infinity.

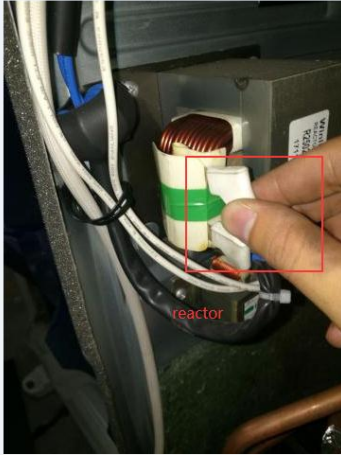

# Typical Troubleshooting Cases

- *Inverter compressor drive error*
- *P4 (PC 04)*

Step 5. check the EEV wiring and resistance.



Red-yellow	Blue-yellow	Brown-white	Orange-white
47Ω	95Ω	47Ω	95Ω

# Typical Troubleshooting Cases

- *Inverter compressor drive error*
- *P4 (PC 04)*

Step 6. check and make sure the liquid and gas valve are fully opened.  
And measure system pressure and make sure the refrigerant is correct.



# Typical Troubleshooting Cases

- *Inverter compressor drive error*
- *P4 (PC 04)*

Step 7. To check whether the compressor sleeve is brown. If yes, it is preliminarily judged as high temperature demagnetization of the compressor



- *Inverter compressor drive error*
- *P4 (PC 04)*

Step 8. To check the running frequency of compressor through the 88 LED on the board or the debugging tool. If the running frequency is Flash. it is preliminarily judged as high temperature demagnetization of the compressor



# THANKS

FOR YOUR ATTENTION

---

Midea Strategic Partners:

