

Code: 22022016015140  
 Model: MOX1-12HFN8DE  
 Brand: MIDEA  
 Order: 62220-N4926108

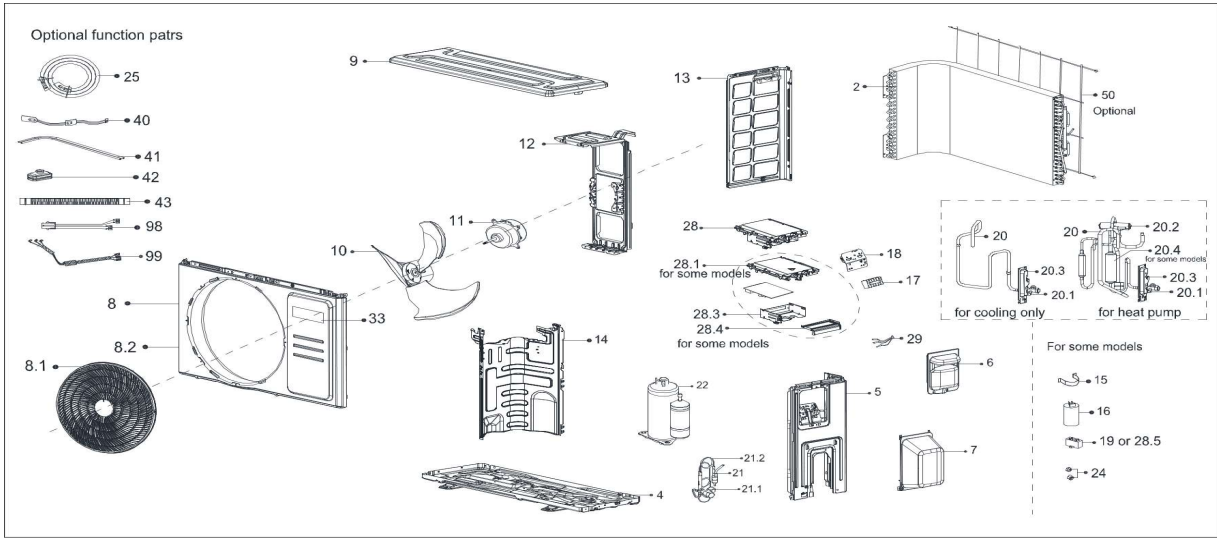

EX_ID	Part Code	Part Name(EN)	Part Name(local)	Qty	Substitute
2	1582200009658	Condenser Assembly	Condenser Assembly	1.00	
4	12222000012131	Chassis Assembly	Chassis Assembly	1.00	
5	12222000012141	Right Clapboard Assembly	Right Clapboard Assembly	1.00	
6	12122000031186	Big Handle Assembly	Big Handle Assembly	1.00	
7	12122000007150	Water Collector	Water Collector	1.00	
8	12222000012205	Front Panel Assembly	Front Panel Assembly	1.00	
8.1	12122000024361	Air-Out Mesh Enclosure	Air-Out Mesh Enclosure	1.00	
8.2	12222000012285	Front panel	Front panel	1.00	12222000012205
9	12222000014305	Top Cover Assembly	Top Cover Assembly	1.00	
10	12100105000821	Axial Flow Fan	Axial Flow Fan	1.00	12100105A00186
11	11002015012128	Brushless DC Motor	Brushless DC Motor	1.00	11002015A01477
12	12222000012390	Motor Bracket	Motor Bracket	1.00	
13	12222000012135	Left Side Panel	Left Side Panel	1.00	
14	12222000012266	Partition Plate	Partition Plate	1.00	
17	17400401000016	Terminal	Terminal	1.00	
18	12222000002259	Terminal Board	Terminal Board	1.00	
20	15422000017673	Four-Way Valve Subassembly	Four-Way Valve Subassembly	1.00	
20.1	15500204000021	Gas Valve	Gas Valve	1.00	
20.2	15500216001903	Four-Way Valve	Four-Way Valve	1.00	
20.3	12222000002571	Valve Plate	Valve Plate	1.00	
20.4	15122000025014	Muffler Subassembly	Muffler Subassembly	1.00	
21	15422000024115	Liquid valve Assembly	Liquid valve Assembly	1.00	
21.1	15500208000028	High Pressure Valve	Liquid Valve	1.00	
21.2	15122000011174	Capillary	Capillary	1.00	
22	11103020005082	DC Inverter Rotary Compressor	DC Inverter Rotary Compressor	1.00	11103020A00576
24	15500406000010	Flare Nut	Copper nut	1.00	15500406000015
24	15500406000016	Flare Nut	Copper nut	1.00	
28	17222000031137	Electronic Control Box Subassembly	Electronic Control Box Subassembly	1.00	
28.1	12122000024223	Support of Electronic Control Box	Support of Electronic Control Box	1.00	
28.3	12222000012106	Electronic Installing Box Subassembly	Electronic Installing Box Subassembly	1.00	
28.4	12122000024222	Fixing board	Fixing board	1.00	
29	11201011000067	Combination Sensor	Combination Sensor	1.00	
33	16022000D06898	Nameplate	Nameplate	1.00	
50	12222000012385	Rear net	Rear net	1.00	
99	17401203012697	Compressor Wires Subassembly	Compressor Wires Subassembly	1.00	