

Code: 22022016016261
 Model: MOX2-12HFN8AD
 Brand: MIDEA
 Order: 62220-N4926801

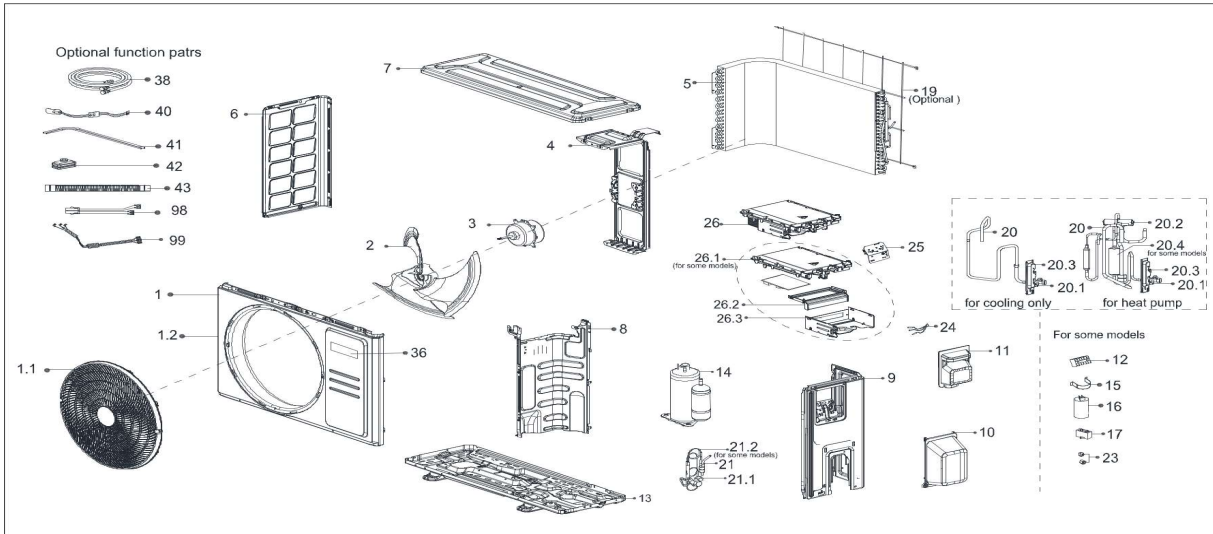

EX_ID	Part Code	Part Name(EN)	Part Name(local)	Qty	Substitute
1	12222000013235	Front Panel Assembly	Front Panel Assembly	1.00	
1.1	12122000026061	Air-Out Mesh Enclosure	Air-Out Mesh Enclosure	1.00	
1.2	12222000013236	Front panel	Front panel	1.00	
2	12100105000961	Axial Flow Fan	Axial Flow Fan	1.00	12100105A00127
3	11002015012128	Brushless DC Motor	Brushless DC Motor	1.00	11002015A01477
4	12222000013233	Motor Bracket	Motor Bracket	1.00	
5	15822000014035	Condenser assembly	Condenser assembly	1.00	
6	12222000013238	Left Side Panel	Left Side Panel	1.00	
7	12222000013240	Top Cover Assembly	Top Cover Assembly	1.00	
8	12222000013232	Partition Plate	Partition Plate	1.00	
9	12222000013225	Right Clapboard Assembly	Right Clapboard Assembly	1.00	
10	12122000007150	Water Collector	Water Collector	1.00	
11	12122000031166	Big Handle Assembly	Big Handle Assembly	1.00	
12	17400401000016	Terminal	Terminal	1.00	
13	12222000013228	Chassis Assembly	Chassis Assembly	1.00	
14	11103020006759	DC Inverter Rotary Compressor	DC Inverter Rotary Compressor	1.00	11103020A00776
19	12222000015606	Rear net	Rear net	1.00	
20	15422000017852	Four-Way Valve Subassembly	Four-Way Valve Subassembly	1.00	
20.1	15500204000021	Gas Valve	Gas Valve	1.00	
20.2	15500216001903	Four-Way Valve	Four-Way Valve	1.00	
20.3	12222000005738	Valve Plate	Valve Plate	1.00	
20.4	15122000026302	Muffler Subassembly	Muffler Subassembly	1.00	
21	15422000018812	Liquid valve assembly	Liquid valve assembly	1.00	
21.1	15500208000028	High Pressure Valve	Liquid Valve	1.00	
23	15500406000010	Flare Nut	Copper nut	1.00	15500406000015
23	15500406000016	Flare Nut	Copper nut	1.00	
24	11201011000067	Combination Sensor	Combination Sensor	1.00	
25	12222000002259	Terminal Board	Terminal Board	1.00	
26	17222000033097	Electronic control box subassembly	Electronic control box subassembly	1.00	
26.1	12122000024223	Support of Electronic Control Box	Support of Electronic Control Box	1.00	
26.2	12122000024222	Fixing board	Fixing board	1.00	
26.3	12222000012106	Electronic Installing Box Subassembly	Electronic Installing Box Subassembly	1.00	
36	16000201001228	Trademark	Trademark	1.00	
99	17401203012697	Compressor Wires Subassembly	Compressor Wires Subassembly	1.00	